



## DADI

### DADI ESAGONALI

- 6S Passo Grosso Neri \_\_\_\_\_ 44
- 6S Passo Grosso Zincati \_\_\_\_\_ 45
- 6S Passo Fine Neri \_\_\_\_\_ 46
- 6S Passo Fine Zincati \_\_\_\_\_ 47
- 8G Passo Grosso / Passo Fine Neri \_\_\_\_\_ 48
- 8G Passo Grosso / Passo Fine Zincati \_\_\_\_\_ 49
- Passo Grosso OTTONE \_\_\_\_\_ 50
- Passo Grosso Inox A2 \_\_\_\_\_ 51
- Passo Grosso NYLON \_\_\_\_\_ 52
- 8G Neri Per Carpenteria \_\_\_\_\_ 52

DADI ESAGONALI A SALDARE 4.8 NERI \_\_\_\_\_ 53

DADI METALBLOC 6S ZINCATI PASSO GROSSO - PASSO FINE \_\_\_\_\_ 53

### DADI CECHI

- 6S Zincati Passo Grosso \_\_\_\_\_ 54
- OTTONE Passo Grosso \_\_\_\_\_ 54
- Inox A2 Passo Grosso \_\_\_\_\_ 55

DADI FLANGIATI A BASE ZIGRINATA 6S ZINCATI \_\_\_\_\_ 55

DADI PROLUNGATI 4S ZINCATI \_\_\_\_\_ 56

CONTRODADI NERI \_\_\_\_\_ 56

### DADI AD ALETTE

- 4S Zincati \_\_\_\_\_ 57
- OTTONE \_\_\_\_\_ 57
- Inox A2 \_\_\_\_\_ 57

DADI A CORONA 4S NERI PASSO GROSSO - PASSO FINE \_\_\_\_\_ 58

### DADI AUTOBLOCCANTI

- 6S Passo Grosso Zincati \_\_\_\_\_ 59
- 6S Passo Fine Zincati \_\_\_\_\_ 60
- Inox A2 Passo Grosso \_\_\_\_\_ 61

## UNI 5587-8-9    DIN 934-936

Classe 6S | 8 |

**GREZZI**

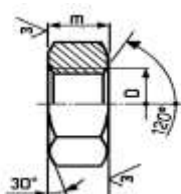

Art. 300

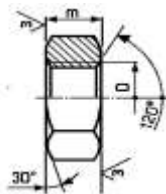

Art. 320

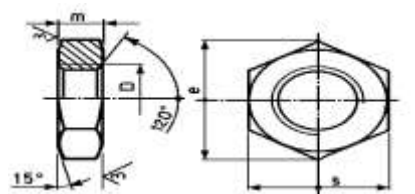

Art. 340

## Dadi esagonali

Filettatura metrica ISO a passo grosso

Prezzo base in €uro per 100 pezzi

5587-65 PG

5588-65 PG

5589-65 PG

Misura	Chiave	Altezza	Prezzo	Misura	Chiave	Altezza	Prezzo	Misura	Chiave	Altezza	Prezzo
3	5,5	3	0,55	3	5,5	2,4	0,40	3	5,5		
4	7	4	0,55	4	7	3,2	0,45	4	7		
5	8	5	0,75	5	8	4	0,50	5	8	3,5	0,75
6	10	6	1,15	6	10	5	0,85	6	10	4	1,05
7	11	7	2,25	7	11	5,5	1,70	7	11	4	2,55
8	13	8	2,25	8	13	6,5	1,70	8	13	5	1,65
10	17	10	4,90	10	17	8	3,60	10	17	6	3,70
12	19	12	6,90	12	19	10	5,40	12	19	7	5,30
14	22	14	11,05	14	22	11	8,00	14	22	8	9,25
16	24	16	14,55	16	24	13	10,90	16	24	8	10,15
18	27	18	22,35	18	27	15	16,15	18	27	9	15,90
20	30	20	29,30	20	30	16	20,40	20	30	9	19,80
22	32	22	38,70	22	32	18	32,30	22	32	10	39,40
24	36	24	50,95	24	36	19	41,00	24	36	10	47,95
27	41	27	74,85	27	41	22	62,25	27	41	12	78,30
30	46	30	115,15	30	46	24	99,00	30	46	12	97,90
33	50	33	346,00	33	50	26	268,60	33	50	14	341,73
36	55	36	459,60	36	55	29	361,60	36	55	14	720,45
39	60	39	588,80	39	60	31	442,20	39	60	16	836,655
42	65	42	712,80	42	65	34	547,50	42	65	16	952,86
45	70	45	888,30	45	70	36	671,40	45	70	18	1162,04
48	75	48	1094,90	48	75	38	826,40	48	75	18	1394,43
52	80	52	1322,20	52	80	42	1033,00	52	80	20	1673,33
56	85	56	1704,30	56	85	45	1260,20	56	85	22	1999,0
60	90	60	2014,20	60	90	48	1549,40	60	90	24	2324,06
64	95	64	2375,70	64	95	51	1807,60	64	95	26	*
68	100	68	2788,90	68	100	54	2220,80	68			*
72	105	72	3460,30	72	105	58	2427,40	72			*
76	110	76	3615,20	76	110	61	2934,80	76			*
80	115	80	4131,70	80	115	64	3150,40	80			*

\* = Prezzi a richiesta

**UNI 5587-8-9    DIN 934-936**  
Classe 6S | 8 |

**ZINCATI**

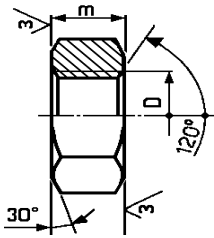

Art. 2020

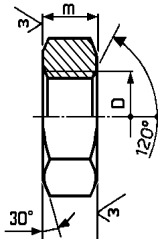

Art. 2022

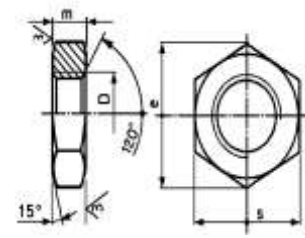

Art. 2340

## Dadi esagonali

Filettatura metrica ISO a passo grosso

Prezzo base in €uro per 100 pezzi

5587-65				5588-65				5589-65			
Misura	Chiave	Altezza	Prezzo	Misura	Chiave	Altezza	Prezzo	Misura	Chiave	Altezza	Prezzo
3	5,5	3	0,60	3	5,5	2,4	0,50				
4	7	4	0,60	4	7	3,2	0,50				
5	8	5	0,80	5	8	4	0,60	5	8	3,5	
6	10	6	1,40	6	10	5	1,05	6	10	4	1,15
7	11	7	2,65	7	11	5,5	2,00	7	11	4	1,50
8	13	8	2,65	8	13	6,5	2,00	8	13	5	1,80
10	17	10	5,65	10	17	8	4,10	10	17	6	4,10
12	19	12	8,10	12	19	10	6,15	12	19	7	6,10
14	22	14	12,90	14	22	11	9,25	14	22	8	10,00
16	24	16	16,40	16	24	13	12,50	16	24	8	11,60
18	27	18	24,70	18	27	15	18,45	18	27	9	17,35
20	30	20	32,70	20	30	16	23,05	20	30	9	21,90
22	32	22	45,15	22	32	18	36,85	22	32	10	42,85
24	36	24	59,65	24	36	19	47,00	24	36	10	59,65
27	41	27	90,00	27	41	22	73,50	27	41	12	93,90
30	46	30	135,85	30	46	24	115,15	30	46	12	115,60

## UNI 5587-8-9    DIN 934-936

Classe 6S | 8 |

**GREZZI**

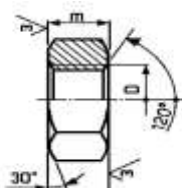

**Art. 310**

( Per Diametro 12x1,5 Art. 311 )

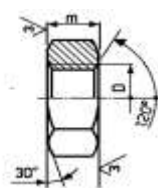

**Art. 330**

( Per Diametro 12x1,5 Art. 321 )

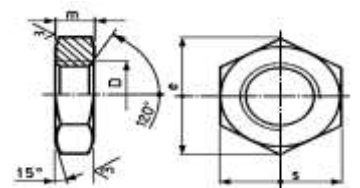

**Art. 350**

( Per Diametro 12x1,5 Art. 351 )

## Dadi esagonali

Filettatura metrica ISO a passo fine

Prezzo base in €uro per 100 pezzi

5587-65 PF				5588-65 PF				5589-65 PF			
Misura	Chiave	Altezza	Prezzo	Misura	Chiave	Altezza	Prezzo	Misura	Chiave	Altezza	Prezzo
8x1	13	8	3,30	8x1	13	6,5	2,40	8x1	13	5	2,65
10x1,2	17	10	8,10	10x1,2	17	8	5,55	10x1,2	17	6	5,95
5				5				5			
12x1,2	19	12	11,60	12x1,2	19	10	8,35	12x1,2	19	7	9,30
5				5				5			
12x1,5	19	12	11,60	12x1,5	19	10	8,35	12x1,5	19	7	9,30
14x1,5	22	14	16,80	14x1,5	22	11	11,10	14x1,5	22	8	14,80
16x1,5	24	16	22,10	16x1,5	24	13	15,20	16x1,5	24	8	16,20
18x1,5	27	18	34,05	18x1,5	27	15	22,60	18x1,5	27	9	25,45
20x1,5	30	20	44,50	20x1,5	30	16	28,60	20x1,5	30	9	31,70
22x1,5	32	22	58,80	22x1,5	32	18	45,15	22x1,5	32	10	63,00
24x2	36	24	77,40	24x2	36	19	57,45	24x2	36	10	76,65
27x2	41	27	113,80	27x2	41	22	87,10	27x2	41	12	125,30
30x2	46	30	175,00	30x2	46	24	138,60	30x2	46	12	156,70
33x2	50	33	377,00	33x2	50	26	294,40	33x2	50	14	239,07
36x3	55	36	495,80	36x3	55	29	397,70	36x3	55	14	716,58
39x3	60	39	635,20	39x3	60	31	480,30	39x3	60	16	1041,95
42x3	65	42	774,70	42x3	65	34	594,00	42x3	65	16	1224,00
45x3	70	45	960,60	45x3	70	36	723,00	45x3	70	18	1262,73
48x3	75	48	1187,90	48x3	75	38	893,50	48x3	75	18	1805,01
52x3	80	52	1430,60	52x3	80	42	1115,60	52x3	80	20	2184,62
56x4	85	56	1838,60	56x4	85	45	1363,50	56x4	85	22	2595,20
60x4	90	60	2169,20	60x4	90	48	1652,70	60x4	90	24	3005,78
64x4	95	64	2566,80	64x4	95	51	1962,60	64x4	95	26	*
68x4	100	68	3016,10	68x4	100	54	2375,70				
72x4	105	72	3460,30	72x4	105	58	2634,00				
76x4	110	76	3904,40	76x4	110	61	3202,00				
80x4	115	80	10725,00	80x4	115	64	3408,60				

**UNI 5587-8-9    DIN 934-936**

**Classe 6S | 8 |**

**ZINCATI**

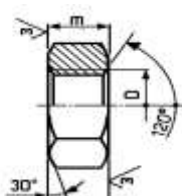

Art. 2310

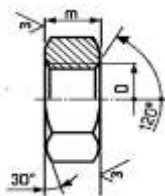

Art. 2330

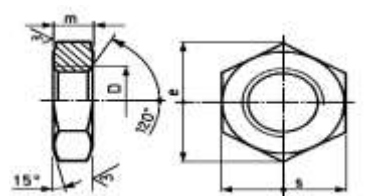

Art. 2350

## Dadi esagonali

Filettatura metrica ISO a passo fine

Prezzo base in €uro per 100 pezzi

5587-65 PF

5588-65 PF

5589-65 PF

Misura	Chiave	Altezza	Prezzo	Misura	Chiave	Altezza	Prezzo	Misura	Chiave	Altezza	Prezzo
8x1	13	8	4,05	8x1	13	6,5	2,95	8x1	13	5	3,00
10x1,2 5	17	10	9,70	10x1,2 5	17	8	6,80	10x1,2 5	17	6	6,80
12x1,2 5	19	12	13,75	12x1,2 5	19	10	10,30	12x1,2 5	19	7	10,40
12x1,5	19	12	13,75	12x1,5	19	10	10,30	12x1,5	19	7	10,40
14x1,5	22	14	20,30	14x1,5	22	11	14,00	14x1,5	22	8	16,30
16x1,5	24	16	26,50	16x1,5	24	13	18,80	16x1,5	24	8	18,00
18x1,5	27	18	40,15	18x1,5	27	15	27,60	18x1,5	27	9	27,75
20x1,5	30	20	52,95	20x1,5	30	16	35,25	20x1,5	30	9	34,50
22x1,5	32	22	68,35	22x1,5	32	18	53,35	22x1,5	32	10	65,25
24x2	36	24	92,05	24x2	36	19	68,50	24x2	36	10	80,00
27x2	41	27	134,55	27x2	41	22	104,35	27x2	41	12	129,75
30x2	46	30	206,20	30x2	46	24	161,50	30x2	46	12	164,75

## UNI 5587-8 DIN 934

### Classe 10 8G

**GREZZI**



UNI 5589 Art. 385

## Dadi esagonali

Filettatura sistema metrico ISO a passo grosso e fine

Prezzo base in €uro per 100 pezzi

**5587 PG**  
Art. 360

**5588 PG**  
Art. 380

**5587 PF**  
Art. 370

**5588 PF**  
Art. 390

Misura	S	H	Prezzo	Misura	S	H	Prezzo	Misura	S	H	Prezzo	Misura	S	H	Prezzo
6	10	6	2,05	6	10	5	1,60	8x1	13	8	5,25	8x1	13	6,5	4,00
8	13	8	4,20	8	13	6,5	3,30	10x1,2	17	10	12,55	10x1,2	17	8	9,00
10	17	10	9,70	10	17	8	7,15	12x1,2	19	12	17,95	12x1,2	19	10	13,65
12	19	12	13,35	12	19	10	10,70	14x1,5	22	14	26,70	14x1,5	22	11	19,00
14	22	14	21,10	14	22	11	15,55	16x1,5	24	16	34,70	16x1,5	24	13	25,20
16	24	16	27,50	16	24	13	20,30	18x1,5	27	18	52,05	18x1,5	27	15	36,70
18	27	18	40,80	18	27	15	30,80	20x1,5	30	20	69,00	20x1,5	30	16	47,05
20	30	20	48,40	20	30	16	38,05	22x1,5	32	22	87,50	22x1,5	32	18	69,20
22	32	22	68,95	22	32	18	56,00	24x2	36	24	120,00	24x2	36	19	89,40
24	36	24	85,20	24	36	19	66,80	27x2	41	27	174,70	27x2	41	22	136,90
27	41	27	135,30	27	41	22	112,10	30x2	46	30	266,90	30x2	46	24	207,40
30	46	30	207,00	30	46	24	149,65	33x2	50	33	501,00	33x2	50	26	402,90
33	50	33	464,80	33	50	26	371,80	36x3	55	36	666,20	36x3	55	29	516,50
36	55	36	614,60	36	55	29	480,30	39x3	60	39	852,20	39x3	60	31	650,80
39	60	39	790,20	39	60	31	599,10	42x3	65	42	1043,20	42x3	65	34	795,40
42	65	42	965,80	42	65	34	738,60	45x3	70	45	1275,60	45x3	70	36	965,80
45	70	45	1182,70	45	70	36	893,50	48x3	75	48	1539,00	48x3	75	38	1162,00
48	75	48	1425,40	48	75	38	1074,20								



## UNI 5587-8 DIN 934

Classe 10 8G

**ZINCATI**

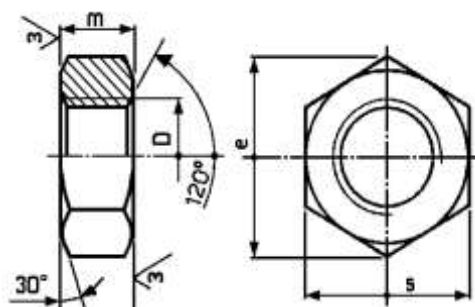
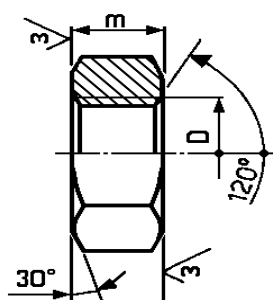

## Dadi esagonali

Filettatura sistema metrico ISO a passo grosso e fine

Prezzo base in €uro per 100 pezzi

**5587 PG**

Art. 2360

**5588 PG**

Art. 2380

**5587 PF**

Art. 2370

**5588 PF**

Art. 2390

Misura	S	H	Prezzo	Misura	S	H	Prezzo	Misura	S	H	Prezzo	Misura	S	H	Prezzo
6	10	6	2,535	6	10	5	1,95								
8	13	8	5,265	8	13	6,5	4,225	8x1	13	8	*	8x1	13	6,5	*
10	17	10	12,025	10	17	8	9,035	10x1,2	17	10	*	10x1,2	17	8	*
			16,705				13,455	5				5			
12	19	12	26,65	12	19	10	19,565	12x1,2	19	12	*	12x1,2	19	10	*
14	22	14	34,32	14	22	11	25,805	5				5			
16	24	16	50,70	16	24	13	48,49	14x1,5	22	14	*	14x1,5	22	11	*
18	27	18	61,62	18	27	15	68,705	16x1,5	24	16	*	16x1,5	24	13	*
20	30	20	85,15	20	30	16	84,76	18x1,5	27	18	*	18x1,5	27	15	*
22	32	22	108,42	22	32	18	138,71	20x1,5	30	20	*	20x1,5	30	16	*
24	36	24	167,70	24	36	19	187,525	22x1,5	32	22	*	22x1,5	32	18	*
27	41	27	256,165	27	41	22		24x2	36	24	*	24x2	36	19	*
30	46	30		30	46	24		27x2	41	27	*	27x2	41	22	*
								30x2	46	30	*	30x2	46	24	*

\* = Prezzi a richiesta

## UNI 5587-8-9 DIN 934-936

OTTONE OT 58

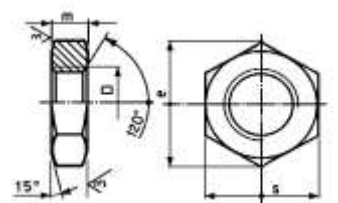
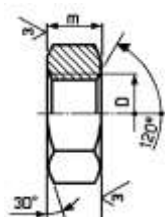
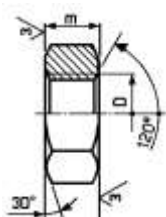

## Dadi esagonali

Filettatura sistema metrico ISO a passo grosso

Prezzo base in € per 100 pezzi

5587 Art. 1340				5588 Art. 1350				5589 Art. 1360			
Misura	Chiave	Altezza	Prezzo	Misura	Chiave	Altezza	Prezzo	Misura	Chiave	Altezza	Prezzo
3	5,5	3	2,10	3	5,5	2,4	1,90	3	5,5	2	1,80
4	7	4	3,20	4	7	3,2	2,90	4	7	2,8	2,70
5	8	5	5,20	5	8	4	4,00	5	8	3	3,60
6	10	6	8,80	6	10	5	7,00	6	10	4	6,60
7	11	7	9,00	7	11	5,5	7,00	7	11	4	6,00
8	13	8	17,60	8	13	6,5	15,50	8	13	5	13,00
10	17	10	44,00	10	17	8	38,00	10	17	6	30,00
12	19	12	60,00	12	19	10	54,00	12	19	7	42,00
14	22	14	90,00	14	22	11	78,00	14	22	8	60,00
16	24	16	125,00	16	24	13	110,00	16	24	8	75,00
18	27	18	180,00	18	27	15	155,00	18	27	9	110,00
20	30	20	250,00	20	30	16	210,00	20	30	9	140,00
22	32	22	320,00	22	32	18	280,00	22	32	10	200,00
24	36	24	450,00	24	36	19	390,00	24	36	10	250,00



## UNI 5587-8-9 DIN 934-936 INOX A2 AISI 304

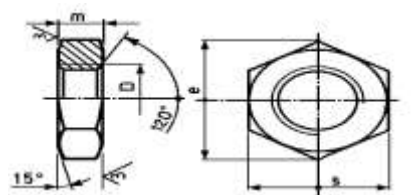
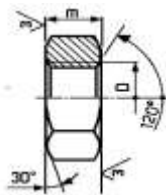
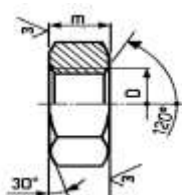

### Dadi esagonali

Prezzo base in Euro per 100 pezzi

**5587-65**  
Art. 1610

**5588-65**  
Art. 1620

**5589-65**  
Art. 1630

Misura	Chiave	Altezza	Prezzo	Misura	Chiave	Altezza	Prezzo	Misura	Chiave	Altezza	Prezzo
				2	4	1,6	2,00				
				2,5	5	2	1,97				
3	5,5	3	2,73	3	5,5	2,4	1,43	3	5,5		4,41
4	7	4	2,79	4	7	3,2	1,65	4	7		3,96
5	8	5	3,66	5	8	4	1,97	5	8	3	3,59
6	10	6	4,66	6	10	5	2,89	6	10	4	3,90
8	13	8	9,05	8	13	6,5	5,97	8	13	5	6,65
10	17	10	19,69	10	17	8	13,26	10	17	6	14,70
12	19	12	28,31	12	19	10	19,24	12	19	7	19,03
14	22	14	55,26	14	22	11	29,09	14	22	8	45,16
16	24	16	67,48	16	24	13	37,28	16	24	8	46,44
18	27	18	181,09	18	27	15	61,12	18	27	9	126,40
20	30	20	149,13	20	30	16	74,57	20	30	9	110,78
22	32	22	351,52	22	32	18	106,92	22	32	10	312,46
24	36	24	409,43	24	36	19	166,44	24	36	10	397,67
27	41	27	909,43	27	41	22	669,74	27	41	12	597,18
30	46	30	1.296,87	30	46	24	785,58	30	46	12	694,01
33	50	33	1.797,53	33	50	26	1.218,32	33	50	14	1.081,36
36	55	36	2.259,50	36	55	29	1.694,65	36	55	14	1.404,14

## UNI 5588 DIN 934

### NYLON

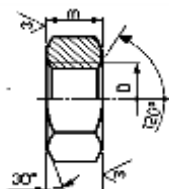

## Dadi esagonali

Filettatura metrica ISO a passo grosso

Art. 5320

Prezzo €uro per 100 pezzi

Misura	Chiave	Altezza	PREZZO
3	5,5	2,4	15,60
4	7	3,2	16,00
5	8	4	16,40
6	10	5	17,20
8	13	6,5	25,40
10	17	8	56,00
12	19	10	59,20
14	22	11	
16	24	13	92,40
18	27	15	
20	30	16	210,00

## UNI 5713 DIN 6915

### Classe 10 8G

**GREZZI**

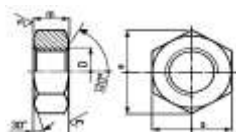

## Dadi esagonali per carpenteria

Filettatura sistema metrico ISO a passo grosso

Art. 391

Prezzo base in €uro per 100 pezzi

d	12	14	16	18	20	22	24	27
passo	1,75	2	2	2,5	2,5	2,5	3	3
chiave	22	24	27	30	32	36	41	46
altezza	10	11	13	15	16	18	19	22
Prezzo	23,80	33,85	33,85	48,55	48,55	84,00	89,90	129,70

## DIN 929

### Classe 5

## GREZZI

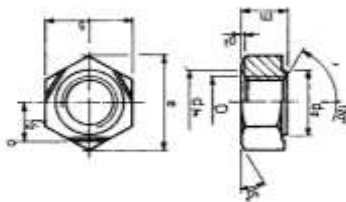

### Dadi esagonali a saldare

Filettatura sistema metrico ISO a passo grosso

Art. 394

Prezzo base in €uro per 100 pezzi

d	4	5	6	8	10	12
passo	0,7	0,8	1	1,25	1,25	1,5
chiave	13	10	11	14	17	19
altezza	2,5	4	5	6,5	8	10
Prezzo	3,41	4,03	4,85	7,95	8,88	13,43

## DIN 980

### Classe 6S

## ZINCATI

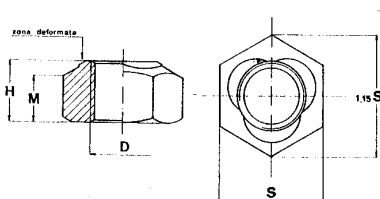

### Dadi esagonali "metalbloc"

Filettatura sistema metrico ISO a passo grosso e passo fine

Art. 395

Prezzo base in €uro per 100 pezzi

d	4	5	6	8	10	12	14	16	20
passo	0,7	0,8	1	1,25	1,5	1,75	2	2	2,5
chiave	7	8	10	13	17	19	22	24	30
altezza	4	5	6	7,5	9	11	12	14	19
Prezzo PG	3,41	3,72	4,13	6,61	11,36	16,53	25,31	33,05	73,34
Prezzo PF					16,27	23,76	51,65	67,14	116,20

## UNI 5721 DIN 1587

### Classe 6S

**ZINCATI**

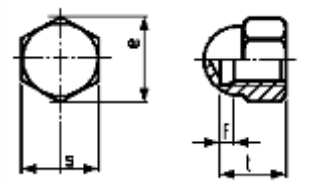

## Dadi ciechi in acciaio con calotta sferica

Filettatura sistema metrico ISO a passo grosso

**Art. 396**

Prezzo base in €uro per 100 pezzi

d	5	6	8	10	12	14	16	18	20	22	24	27
chiave	8	10	13	17	19	22	24	27	30	32	36	
altezza	11	13	16	19	22	25	28	32	34	39	42	
altezza	10	12	15	18	22	25	28	32	34			
Prezzo	13	15	21	34	45	72	88	194	158	562	483	852

## UNI 5721 DIN 1587

### OTTONE OT 58

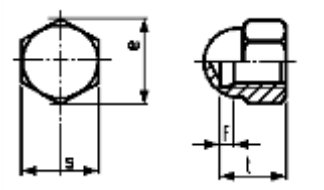

## Dadi ciechi in acciaio con calotta sferica

Filettatura sistema metrico ISO a passo grosso

**Art. 1370**

Prezzo base in €uro per 100 pezzi

d	M 3	M 4	M 5	M 6	M 8	M 10	M 12	M 14	M 16	M 18	M 20
chiave	5,5	7	8	10	13	15	19	22	24	27	30
altezza	5,5	7	8	10	13	14	16	20	23	24	25
Prezzo	8,00	9,20	11,80	16,00	29,00	45,00	92,00	135,00	180,00	270,00	365,00

## UNI 5721 DIN 1587

INOX A2 AISI 304

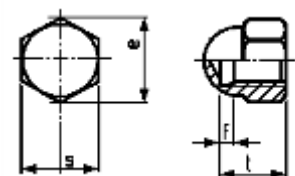

## Dadi ciechi in acciaio con calotta sferica

Filettatura sistema metrico ISO a passo grosso

Art. 1640

Prezzo base in €uro per 100 pezzi

d	3	4	5	6	8	10	12	14	16	18	20	22	24
Prezzo	29,20	21,16	19,74	21,59	40,34	70,87	112,06	312,46	333,76	607,82	744,32	1096,49	1211,66

## DIN 6923

Classe 6S 8

Caratt. Mecc.: HRB>89

ZINCATI

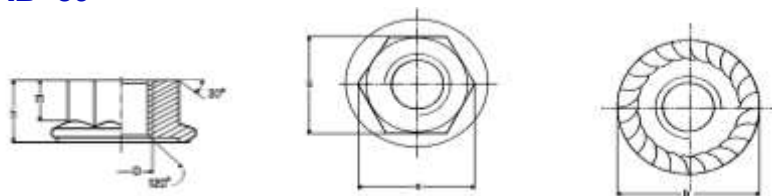

## Dadi flangiati a base zigrinata

Art. 397

Prezzo base in €uro per 100 pezzi

FILETTATURA D	S	e	h	m	d	d1	c	PREZZO
D (6h)		min	max	min	max			
M 5	8	8,79	5	2,2	11,8	9,8	1	6,20
M 6	10	11,05	6	3,1	14,2	12,2	1,1	7,23
M 8	13	14,38	8	4,5	17,9	15,8	1,2	12,91
M 10	15	16,64	10	5,5	21,8	19,6	1,5	30,99
M 12	18	21,10	11,3	6,7	25	23,8	1,8	46,48

## Dadi di giunzione Classe 6S

**ZINCATI**

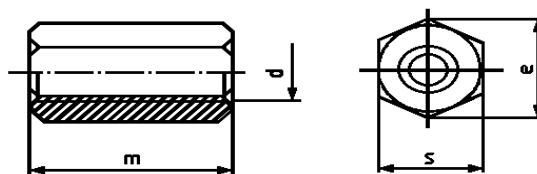

## Dadi esagonali prolungati

Art. 490

Prezzo base in €uro per 100 pezzi

Misura	s	m	e	Prezzo
M 6	10	30	11,05	46,00
M 8	13	40	14,38	52,00
M 10	17	45	18,90	70,00
M 12	19	50	21,10	129,00
M 14	22	55	24,49	517,00
M 16	24	60	26,75	276,00
M 20	30	40	32,95	690,00

## UNI 8835 DIN 7967

**GREZZI**

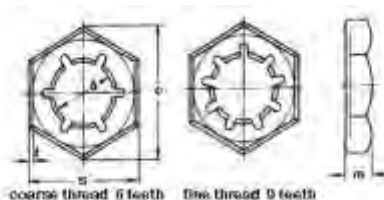

## Controdadi di sicurezza PAL

Passo grosso

Art. 495

Prezzo base in €uro per 100 pezzi

Misura	d	s	m	e	Prezzo
M 6	5,3	10	3	11,5	12,00
M 8	6,9	13	3,5	15	10,60
M 10	8,6	17	4	19,6	11,70
M 12	10,4	19	4,5	21,9	13,40
M 14	12	22	5	25,4	29,80
M 16	14,1	24	5	27,7	18,30
M 18	15,5	27	5,5	31,2	38,50
M 20	17,6	30	6	34,6	26,00
M 22	19,6	32	6	36,9	33,50
M 24	21	36	7	41,6	35,20
M 27	24,2	41	7	47,3	46,60
M 30	26,6	46	8	53,1	60,15
M 36	32,2	55	9	63,5	210,00



## UNI 5448-71 DIN 314

Classe 4.8

ZINCATI

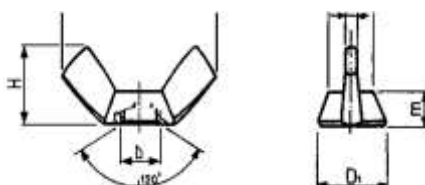

### Dadi ferro ad alette stampati a freddo

Art. 398

Prezzo base in €uro per 100 pezzi

d	3	4	5	6	8	10	12	14	16
Prezzo	10,33	10,33	10,33	12,39	17,56	24,79	56,81	134,28	134,28

## UNI 5448-71 DIN 314

OTTONE OT 63



### Dadi ad alette stampati a freddo

Art. 1400

Prezzo base in €uro per 100 pezzi

d	M 3	M 4	M 5	M 6	M 8	M 10	M 12	M 14	M 16
Prezzo	50	50	50	54	70	102	139	325	325

## UNI 5448-71 DIN 314

INOX A2 AISI 304



### Dadi ad alette

Art. 1660

Prezzo base in €uro per 100 pezzi

d	3	4	5	6	8	10	12	14	16	18	20
Prezzo	29,05	29,05	29,05	29,05	52,29	77,47	174,30	367,98	367,98	619,75	619,75

**UNI 5593 - 5594**  
Classe 6S

**GREZZI**

**Dadi esagonali torniti corona con intagli**

Filettatura ISO a passo grosso e fine

Prezzo base in €uro per 100 pezzi

UNI 5593 Art. 470 PG Art. 475 PF				UNI 5594 Art. 480 PG Art. 485 PF			
d	s	h	prezzo	d	s	h	prezzo
8	13	9,5	34	8	13	8	33
10	17	12	43	10	17	10	42
12	19	15	51	12	19	12	47
14	22	16	65	14	22	13	59
16	24	19	80	16	24	14	69
18	27	21	97	18	27	15	90
20	30	22	125	20	30	15	113
22	32	26	181	22	32	18	145
24	36	27	210	24	36	18	163
27	41	30	300	27	41	20	235
30	46	33	380	30	46	21	307
33	50	35	466	33	50	23	380
36	55	38	625	36	55	23	479
39	60	40	759	39	60	25	615
42	65	46	1121	42	65	28	795
45	70	48	1609	45	70	30	1301
48	75	50	1963	48	75	30	1518
52	80	54	2298	52	80	32	1808
56	85	57	2531	56	85	37	2079

## UNI 7473-7474 DIN 982-985

Classe 6S 8

**ZINCATI**

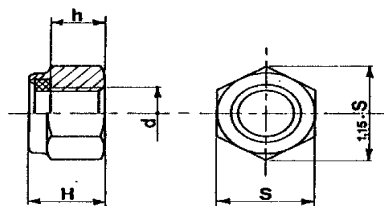

UNI 7473 - DIN 982 (alto)

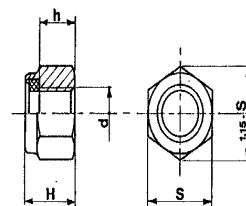

UNI 7474 - DIN 985 (basso)

## Dadi esagonali autobloccanti

Filettatura sistema metrico ISO a passo grosso

Prezzo base in €uro per 100 pezzi

UNI 7473

Art. 500

UNI 7474

Art. 510

misura	chiave	altezza	prezzo	misura	chiave	altezza	prezzo
M 3	5,5	4	5,00	M 4	7	5	4,00
M 4	7	5,8	5,00	M 5	8	5	3,00
M 5	8	6,3	3,00	M 6	10	6	3,00
M 6	10	8	4,00	M 7	11	6,7	5,00
M 7	11	8,8	5,00	M 8	13	8	4,00
M 8	13	9,5	5,00	M 10	17	10	8,00
M 10	17	11,5	9,00	M 12	19	12	11,00
M 12	19	14	12,00	M 14	22	14	19,00
M 14	22	16	21,00	M 16	24	15	25,00
M 16	24	18	29,00	M 18	27	17	46,00
M 18	27	20	52,00	M 20	30	17	60,00
M 20	30	22	72,00	M 22	32	19	72,00
M 22	32	25	89,00	M 24	36	21	99,00
M 24	36	28	120,00	M 27	41	23	260,00
M 27	41	31	290,00	M 30	46	25	320,00
M 30	46	33	360,00	M 33	50	25	440,00
M 33	50	35	465,00	M 36	55	29	580,00
M 36	55	39	620,00	M 39	60	31	710,00
M 39	60	42	780,00	M 42	65	32	1100,00
M 42	65	45	1150,00	M 45	70	34	1450,00
M 45	70	47	1500,00	M 48	75	38	2000,00
M 48	75	52	2100,00				

## UNI 7473-7474 - DIN 982-985

Classe 6S | 8 |

**ZINCATI**

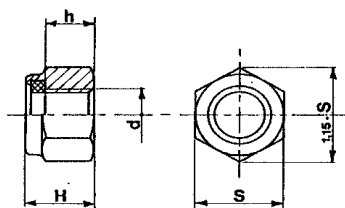

UNI 7473 - DIN 982 (alto)

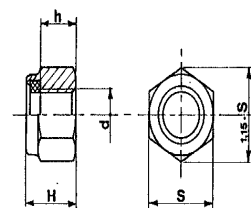

UNI 7474 - DIN -985 (basso)

## Dadi esagonali autobloccanti

Filettatura sistema metrico ISO a passo fine

Prezzo base in Euro per 100 pezzi

### UNI 7473 NORMALE PF

Art. 520

### UNI 7474 BASSO PF

Art. 530

misura	chiave	altezza	prezzo	misura	chiave	altezza	prezzo
8x1	13	9,5	6,00	8x1	13	8	5,00
10x1,25	17	11,5	10,00	10x1,25	17	10	9,00
12x1,25	19	14	14,00	12x1,25	19	12	12,00
12x1,5	19	14	36,00	12x1,5	19	12	31,00
14x1,5	22	16	24,00	14x1,5	22	14	22,00
16x1,5	24	18	33,00	16x1,5	24	15	29,00
18x1,5	27	20	59,00	18x1,5	27	17	53,00
20x1,5	30	22	83,00	20x1,5	30	17	69,00
22x1,5	32	25	102,00	22x1,5	32	19	83,00
24x2	36	28	138,00	24x2	36	21	114,00
27x2	41	31	348,00	27x2	41	23	312,00
30x2	46	33	432,00	30x2	46	25	384,00
33x2	50	35	558,00	33x2	50	25	528,00
36x3	55	39	745,00	36x3	55	29	696,00
39x3	60	42	940,00	39x3	60	31	852,00
42x3	65	45	1380,00	42x3	65	32	1320,00
45x3	70	47	1800,00	45x3	70	34	1740,00
48x3	75	52	2520,00	48x3	75	38	2400,00

## UNI 7474 DIN 985

INOX A2 AISI 304

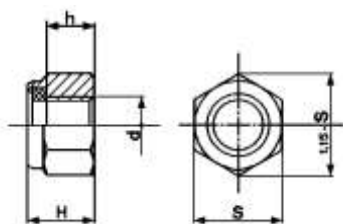

### Dadi esagonali autobloccanti

Art. 1650

Prezzo base in €uro per 100 pezzi

d	3	4	5	6	8	10	12	14
Prezzo	4,09	3,84	4,01	4,41	9,02	19,88	29,83	56,01

d	16	18	20	22	24	27	30
Prezzo	67,74	379,48	383,47	672,43	859,07	1258,86	2616,37